

Cooling System Principles

by



&



Cooling System Principles

Often, it is hard to find information about the function of the automotive cooling system. We at Saldana Racing Products and our good friends at Meziere Enterprises have collaborated together to create this informational guide.

Engine Tune

Engine tuning can be attributed as one of the greatest factors to water and oil temperature. Engine tuning is an array of adjustments and/or modifications of an engine that is designed to yield optimal performance, and increase power output, economy, and/or durability.

Running a lean mixture of fuel and air, and/or a retarded timing situation can cause rapid heating. A lean mixture will cause the engine to burn hot, causing detonation and pre-ignition; while retard timing will make the engine work harder to compress the fuel/air mixture.

The Other 5 Factors

Other than engine tuning, there are five other factors that can affect the cooling system.

- Heat Production (BTUs/HP)
- Radiator Capacity (heat dissipation)
- Air Flow
- Water Flow
- Pump & System pressure

BTUs

BTU stands for the British Thermal Unit and it is used to measure heat value. Simple math can be used to convert horsepower (HP) into BTU. The equation is: A HP/minute = 42.44 BTU. Roughly one-third of the engine's heat goes into the water and must be dissipated by the radiator.

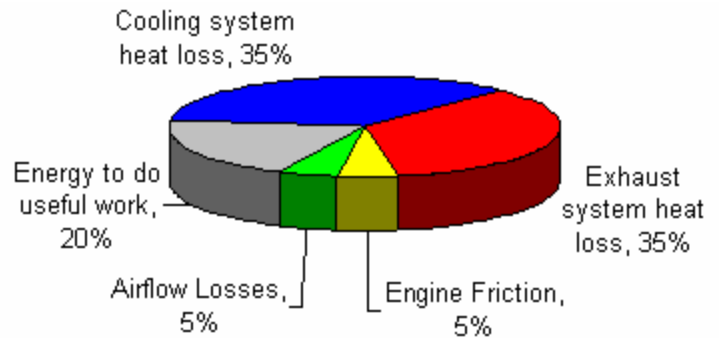

Heat Dissipation

For our discussion, radiator capacity will refer to the amount of heat that can be dissipated; not the amount of coolant a radiator can hold. To calculate radiator capacity, continuous HP is used, not maximum HP. For instance, a 500 HP stock car will need more cooling capacity than an 850 HP dragster. In a ten minute segment, the stock car would generate roughly 180,000 BTU; while dragster might idle less than ten minutes and make an eight second run with a 750 HP average. At full throttle for ten seconds, the dragster would emit about 6,000 BTU. For this reason, the cooling system for the

dragster must be adequate enough to prevent detonation while in full power and maintain temperatures when idling.

Radiator Design

Traditionally, copper and brass were the choice materials when building radiators; but within the last two decades, aluminum has become the new material of choice. Furthermore, design changes in the radiator cores have widened rows from $\frac{1}{2}$ " – $\frac{3}{4}$ " to 1" – 1 $\frac{1}{2}$ ". The wider rows provide more surface area to dissipate heat.

Another design change has been the use of the double pass radiator. This radiator is designed to force water to pass through it twice; though restriction has more than doubled.

Doubling the square inch of a radiator will cause the heat dissipation to double; but by doubling the thickness of a radiator, you will lose efficiency and restrict air flow.

Other factors to the design of radiators are the fin counts per inch and the tank configuration, such as down flow (top tank) or cross flow (side tanks). The size of the inlet and outlet are another factor when designing a radiator.

Coolants

Many coolants will vary in the way they will transfer heat. Regular water is generally accepted as the most efficient coolant. But a glycol-based coolant tends to increase the boiling point, lubricate the pump seal, reduce corrosion, and prevent freezing.

Many sanctioning bodies do not allow glycol-based coolants due to the track clean up; though, anti-corrosion/seal conditioner additives can be added and are available at many auto parts stores. Before making a decision on coolant and/or additives, we highly recommend that you do some research. Many of these products have merit, but there are a few out there that are more about marketing than science.

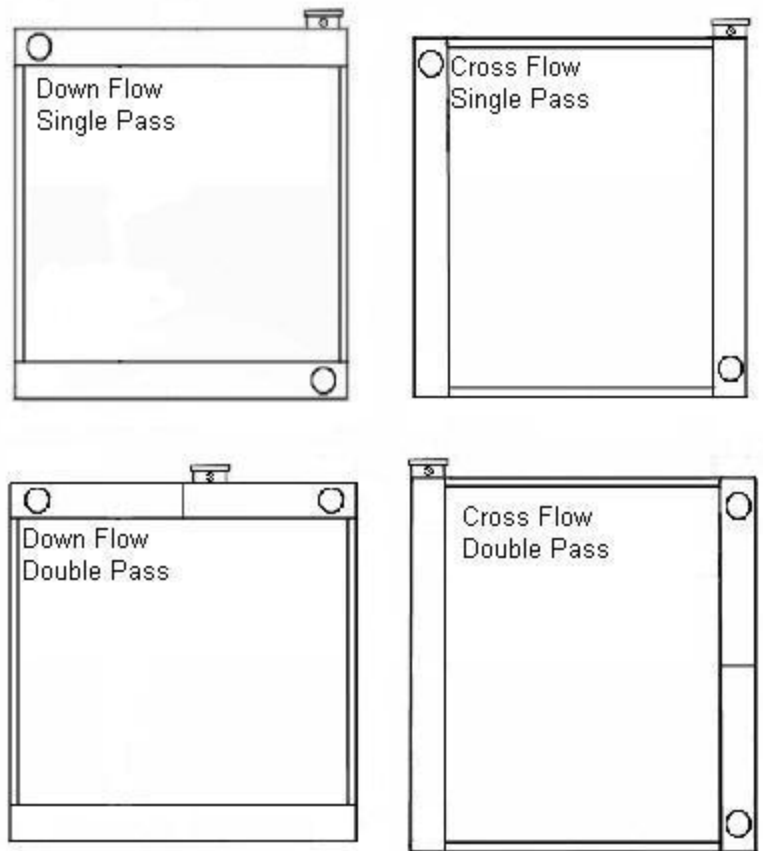

Air Flow

The purpose of a radiator is to transfer heat from the core fins to the air. For this reason, the most crucial factor in a cooling system is the air flow; this can affect the efficiency of a radiator. When selecting a radiator, the speed of the vehicle should be part of the consideration.

For example, stock car teams use different radiators for the different tracks they race at. They would run a full sized radiator for a short track, but will use a smaller radiator at a super speedway.

Maintaining adequate air flow at various speeds is critical and more complex than one would think. To begin with, a radiator needs to be supplied with fresh air. This makes the grill opening or air inlet key to the performance of your radiator. Ideally, the radiator should be squared to the wind. The size of an opening should be proportional to the vehicle speed. For instance, a stock car running at 180 mph can run cool with less than a 6" x 6" opening, while a short track late model running with half the horse power and an average speed of 90 mph, they will require a 6" x 24" opening.

Scoops, bills, deflectors, and recessed screens can be used to improve air flow when the surfaces are less than ideal. Continuous duty race cars (stock cars, sports cars, rally, etc.) have a well designed, tightly sealed air box that is designed to force all the inducted air through the radiator. This tightly sealed air box will also prevent the inducted air from mixing with air that has been heated by the engine. To maintain air velocity, the air box should slowly graduate from the inlet to the size of the radiator.

The next consideration for air flow would be a fan. While driving with speeds typically under 30 mph, electric fans are the most effective; due to them operating independently from the engine RPM. With a good grill opening and/or air box and driving above 35 mph, fans are not necessary. Most electric fans will come with an integral shroud used to maximize efficiency; but if the shroud does not encompass the entire radiator core, air would only be pulled through the area directly in front of the blade circle. Also, there needs to be a minimum of 1" between the shroud and core to maximize air flow. There are some cases where trap doors are installed on a shroud to help relieve back pressure.

Just like electric fans, engine driven fans also must be properly shrouded to be effective. The fan blades should have no more than 1" clearance to the shroud, for instance a 15" fan with a 17" opening. Be careful, some stock engine driven fans can reach a blade stall at high rpm, causing a "wall" that prevents air from passing through it.

To function properly, the air stream on the front side of the radiators needs to be higher than the air stream behind it. The higher pressure is used to drive the fresh air through the



fins. If there is a build up of air pressure in the fan shroud or engine compartment, air flow across the radiator can stall, causing higher engine temperatures. For this reason, thoughtful consideration should be done for both “at rest” state and “at speed” state, as well as effectively channeling of fresh air to the radiator while in both states.

For example, an electric fan and shroud that covers the entire core could install “trap doors” to assist with the efficiency. When “at rest,” these trap doors will stay closed to prevent bypass. While “at speed,” the doors will open to allow more air flow and prevent the shroud from damming the air.

Since the engine compartment must be able to maintain pressure differential as a vehicle’s speed increases, many auto makers started using air dams to increase the pressure at the radiator and block the air from passing under the car.

For more information about electric fans, please contact our friends at SPAL, www.spal.com.

Water Flow

The water flow seems to be the last aspect to be addressed; but it is typically where the majority of cooling system problems lie. A standard stock water pump has excessive clearance and straight impeller blades, usually open front and back. At low rpm, this produces little flow and is responsible for cars to overheat while sitting in traffic. At high rpm, this design produces cavitation and aeration.

Circle track racers crutch this high rpm condition with under-drive pulleys; only to find that the engine would overheat during caution laps. A common misconception comes from this under-drive solution; many people believe that slowing down their water flow has fixed their overheating problems, when in fact it was reducing cavitation by slowing the pump that provided the solution.

In engine driven situations, the only remedy is a quality racing pump with tight clearances and a swept blade closed impeller. Where rules and regulations permit, electric water pumps can be a solution with multiple benefits. The constant speed of an electric pump eliminates the high/low rpm problems. A bonus is that the pump can run when the engine is shut off. Never run your engine with a water pump turned off; this could cause hot spots to form on the cylinder head even before the temperature gauge begins to register.

Mated with a good electric fan, you can easily regulate water temperature for consistency and rapidly cool the engine between rounds after shutdown. For more information about water pumps, please contact our friends at Meziere Enterprises, www.meziere.com.

Pump and System Pressure

For every pound of pressure in a closed system, the boiling point (212°F at sea level) is increased by three degrees. For example, a 16 lb cap would increase the boiling point to

260°F ($16 \times 3 = 48 + 212 = 260$). For some, they may think that they'll run over 210° but even if the temperature gage is reading 190°, hot spots can form around the combustion chamber, creating temperatures well over the boiling temperature of 212°F.

With a poorly sealed system, a low pressure cap, or low water level, a runaway boil over could occur due to the lack of pressure; causing boiling to start prematurely. The gas produced by this boiling aerates the coolant. Water is then diverted around these steam pockets, leading to more serious problems: surface distortion, metal fatigue and cracks. Once this process begins, it will not stop while the engine is under a load. Water flow, temperature, and pressure all work to manage this boiling at hot spots, which can produce steam pockets that insulate the metal from the coolant.

The higher the pressure produced by the water pump, the less chance of the steam pockets forming. Racing pumps can generate pressure in the water jacket in excess of 30 psi to control hot spots and reduce detonation or pre-ignition.

Recommended Operating Temperatures

There are many factors that determine the engine temperature: block and head castings, metal properties, proper combustion and machined clearances.

There are a few theories on coolant temperatures. For drag racers, cold water (under 170°F) and hot oil (230°F) is a standard. In most other forms of racing and street applications, higher temperatures of 190°F to 210°F are ideal because the engine is under power for longer periods of time. Most Chevy small blocks and early domestic V8s are in the temperature range.

Different types of fuels will react differently to temperature and combustion pressure. Low octane gasoline burns more completely at higher temperatures, so manufactures design late model engines to operate up to 210°F. Alcohol has a narrow window for proper combustion. Many tuners recommend a water temperature between 195°F and 205°F. This temperature range is to avoid fuel washing of the cylinders from an incomplete burn (under 195°F) and to avoid harmful deposits left by combustion byproduct (over 205°F). The engine builder would set the internal clearances, such as piston to wall and ring gap, to a predetermined operating temperature.

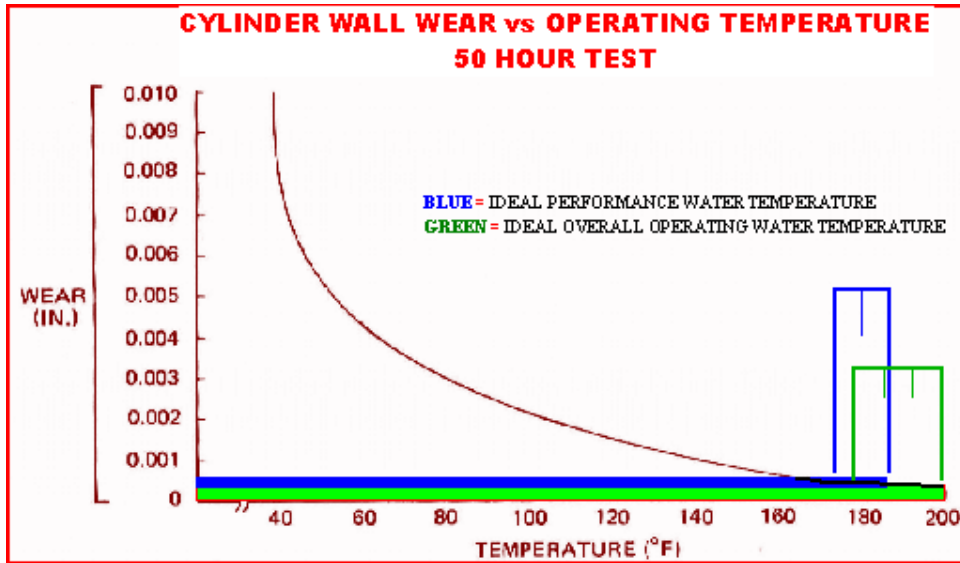

*Graph from <http://www.carnut.com/ramblin/cool3.html>

Thermostat

The primary purpose of a thermostat is to quickly bring the engine temperature up to the recommended operating temperature. Other than drag racing, a thermostat is recommended for most applications.

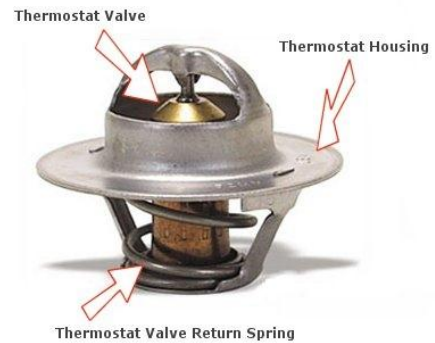

Pressure Cap

As previously mentioned, the more pressure you can hold in a closed system, the higher the boiling point. It is recommended to run the highest pressure cap your system can handle. Check the cap periodically to make sure it is maintaining the advertised pressure. From time to time the rubber seal on the cap may harden and form an impression from the seat in the filler neck.

A new cap should be used whenever the filler neck or radiator is replaced. The filler neck is typically made from cast or formed metal. If the pressure cap seat is defective, distorted, or poorly designed, you will lose water while the engine is running. The lack of pressure on the system builds heat faster, making the engine hotter faster.

Normally Closed or Spring pressed Vacuum Valve Radiator Cap

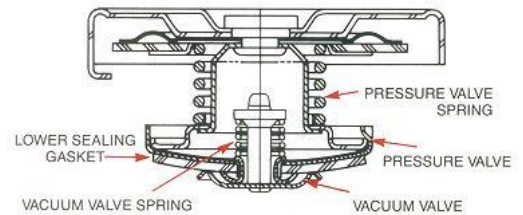

Open or Weighted Vacuum Valve Radiator Cap

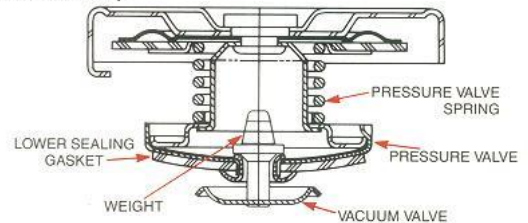

For more information about radiator caps, please contact our friends at Stant;
www.stant.com.

Recovery System

Keeping the system full reduces aeration and maintains pressure. As the temperature increases, the water expands and builds pressure. If the system is completely full, the expansion pressure will exceed the cap pressure and overflow into the recovery tank. If your pressure cap is properly located on the low pressure side of the system, air is pushed out first. When the system cools, a vacuum is created.

The radiator cap is equipped with a valve that opens under negative pressure, and it will draw coolant back into the system. The tube that extends to the bottom of the recovery tank transfers the coolant back into the radiator.

When mounting the recovery tank, make sure the tank is as close to the pressure cap. The feed line should be short and level, this will reduce restriction and the effects of gravity. With the recovery tank 1/3 full (with a cold engine), every heat cycle will automatically purge more air out of the system.

The opposite is true without a recovery system. In every heat cycle, water will be pushed out, leaving more room for air to get in. This air space can be compressed, lowering the boiling point.

Catch Can

A catch-can should not be confused with a recovery can. A catch-can does not facilitate the action of returning the fluid to the system as it cools. Most sanctioning bodies require at least a one pint or larger catch can to contain water overflow from the cooling system. The only benefit to a catch can is to determine how bad your over heating condition is based on the amount of coolant you drain from it.

Expansion Tank

An expansion tank is sometimes referred to as a surge tank, header tank or air separator. The tank has two main functions: (1) it is used as a fill point when the top of your radiator is lower than the engine's water outlet, (2) it can be used to deal with the expanding volume of water when a recovery system is not utilized. The bottom of the tank is plumbed to the low pressure (suction) side of the cooling system (after the radiator core and before the pump impeller). The smaller fitting on the upper portion of the tank is plumbed to the high points on the engine and radiator to remove trapped air and aerated water. This reservoir is located high and out of the main flow of water, and allows air to separate out of the water making your cooling system more efficient.

System Configurations

The following illustrations are examples of the correct way to plumb a typical automotive and racing cooling system.

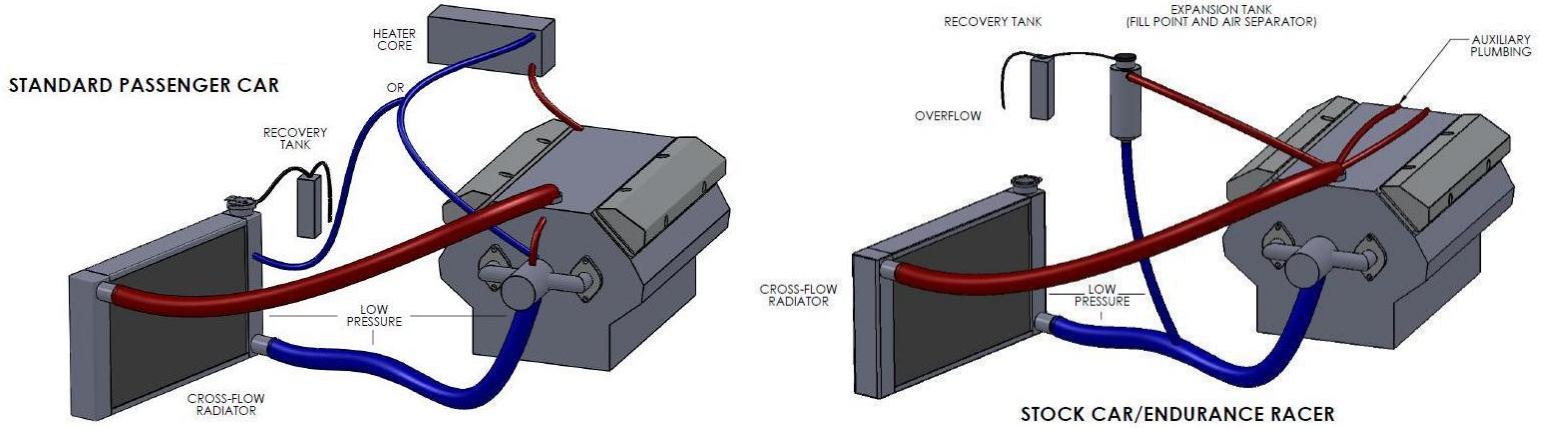

Hopefully this information will help you when considering a new radiator. Thank you again to our friends at Meziere Enterprises for supplying us with much of this information.